

# JUWEL®

## Aquariums & Accessories

Valid from 2024



[www.juwel-aquarium.com](http://www.juwel-aquarium.com)



German Standards **DS**

2022

**BRAND OF THE CENTURY**

**JUWEL**<sup>®</sup>  
AQUARIUM

[www.deutsche-standards.de](http://www.deutsche-standards.de)

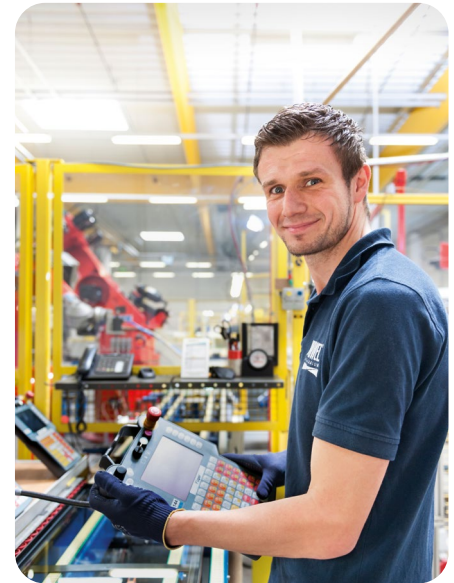

## JUWEL Aquarium

# Aquariums of the highest quality from Germany

For more than 50 years JUWEL Aquarium has been synonymous with quality and innovation in aquarium manufacturing and thus sets standards in design and technology. Emphasis was placed on a systems concept right from the start.

We therefore developed the technology required for the successful operation of an aquarium from early on and our first brand was able to offer a range of aquariums with components that are all perfectly compatible with each other.

We have remained true to this principle, so that today, JUWEL Aquarium is synonymous with high-quality system aquariums, ultra-modern technology and the highest quality standards.

To this day, an experienced team is constantly working with great enthusiasm to create a beautiful home for your fish. This performance has made us the brand of the century as well as Europe's no. 1 aquarium brand.

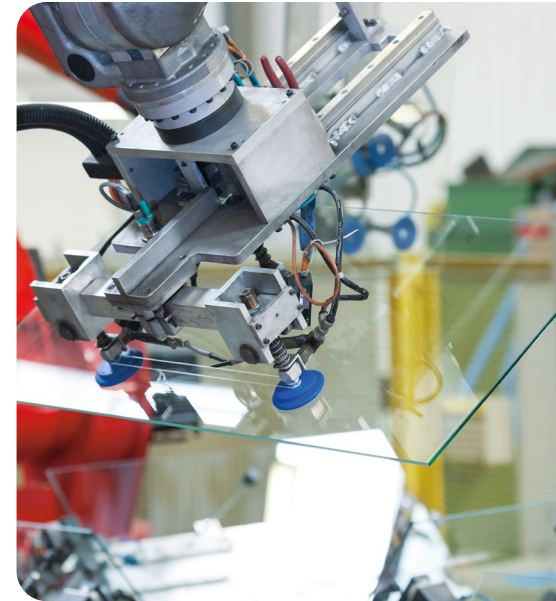

Precision and the latest manufacturing technology in all production steps



New  
Rio 290

Rio 290



## Rio 290 → from autumn 2024

The new Rio 290, with its compact shape and unusual height and depth, was added to the Rio line to allow for even more design options.



Rio 290



Find out more on page 9



Rio 180



## Rio 125

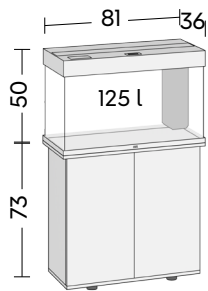

**Lighting**  
MultiLux 80

**Filter Type**  
Bioflow M

**Filter Performance**  
500 l/h, 5,5 Watt

**Adjustable Heater**  
100 Watt

## Rio 180

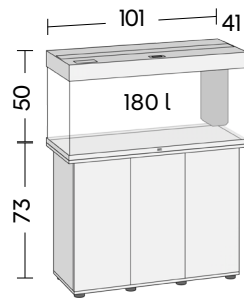

**Lighting**  
MultiLux 100

**Filter Type**  
Bioflow M

**Filter Performance**  
600 l/h, 7 Watt

**Adjustable Heater**  
200 Watt

## Rio 240

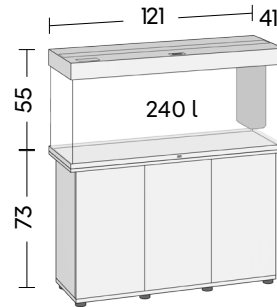

**Lighting**  
MultiLux 120

**Filter Type**  
Bioflow M

**Filter Performance**  
600 l/h, 7 Watt

**Adjustable Heater**  
200 Watt



Black



Grey



White



Light wood



Rio 450

Quality  
made in  
Germany



## Rio 290 NEW

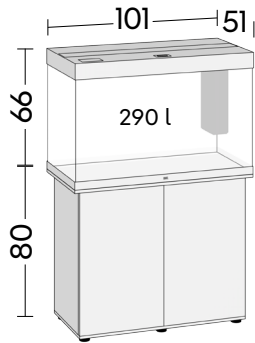

**Lighting**  
MultiLux 100

**Filter Type**  
Bioflow L

**Filter Performance**  
1000 l/h, 8 Watt

**Adjustable Heater**  
300 Watt

## Rio 350

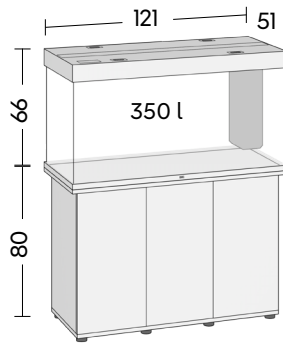

**Lighting**  
MultiLux 120

**Filter Type**  
Bioflow L

**Filter Performance**  
1000 l/h, 8 Watt

**Adjustable Heater**  
300 Watt

## Rio 450

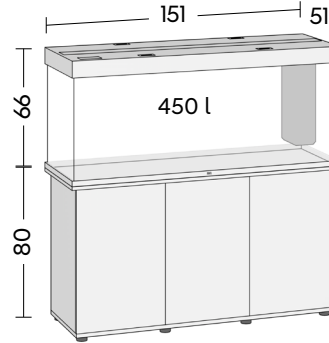

**Lighting**  
MultiLux 150

**Filter Type**  
Bioflow XL

**Filter Performance**  
1000 l/h, 8 Watt

**Adjustable Heater**  
300 Watt

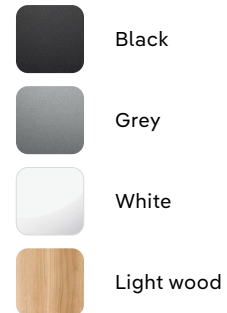



Lido 200



## Lido 120

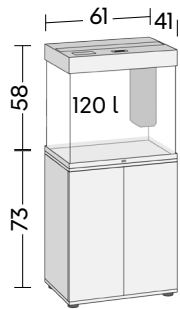

**Lighting**  
MultiLux 60

**Filter Type**  
Bioflow M

**Filter Performance**  
500 l/h, 5,5 Watt

**Adjustable Heater**  
100 Watt

## Lido 200

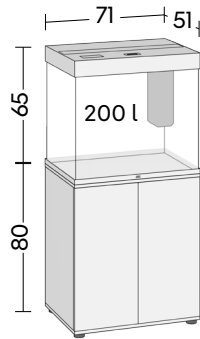

**Lighting**  
MultiLux 70

**Filter Type**  
Bioflow M

**Filter Performance**  
600 l/h, 7 Watt

**Adjustable Heater**  
200 Watt



Black



Grey



White



Light wood

Lido 200





Vision 180



## Vision 180

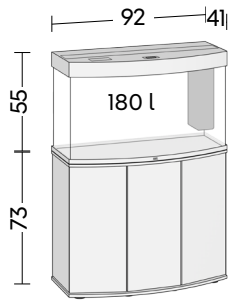

**Lighting**  
MultiLux 92

**Filter Type**  
Bioflow M

**Filter Performance**  
600 l/h, 7 Watt

**Adjustable Heater**  
200 Watt

## Vision 260

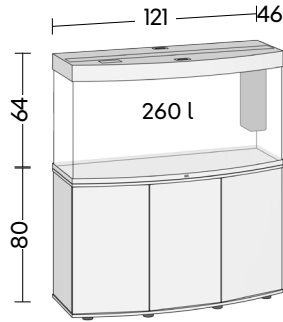

**Lighting**  
MultiLux 120

**Filter Type**  
Bioflow L

**Filter Performance**  
1000 l/h, 8 Watt

**Adjustable Heater**  
300 Watt

## Vision 450

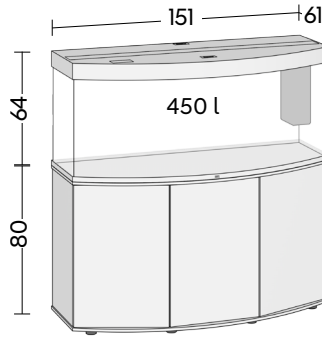

**Lighting**  
MultiLux 150

**Filter Type**  
Bioflow XL

**Filter Performance**  
1000 l/h, 8 Watt

**Adjustable Heater**  
300 Watt



Black



White



Light wood



Trigon 190



## Trigon 190

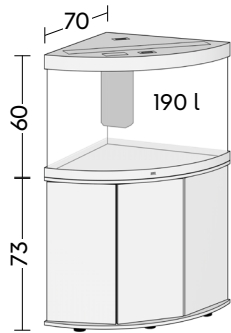

**Lighting**  
MultiLux 70

**Filter Type**  
Bioflow M

**Filter Performance**  
600 l/h, 7 Watt

**Adjustable Heater**  
200 Watt

## Trigon 350

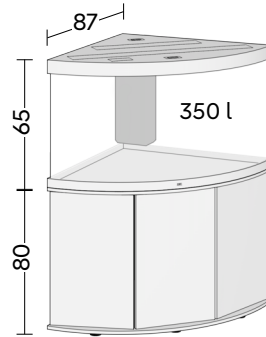

**Lighting**  
MultiLux 55 & 100

**Filter Type**  
Bioflow XL

**Filter Performance**  
1000 l/h, 8 Watt

**Adjustable Heater**  
300 Watt



Black



White



Light wood

Trigon 190





New  
2.0

Primo 70 2.0

Quality  
made in  
Germany



## Primo 60 2.0 NEW

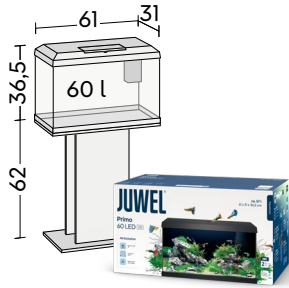

### Lighting

NovoLux LED 60, 8 Watt

### Filter Type

Bioflow One

### Filter Performance

300 l/h, 4,4 Watt

### Adjustable Heater

50 Watt



Black

## Primo 70 2.0 NEW



### Lighting

NovoLux LED 60, 8 Watt

### Filter Type

Bioflow S

### Filter Performance

300 l/h, 4,4 Watt

### Adjustable Heater

100 Watt



Black



White

## Primo 110 2.0 NEW



### Lighting

NovoLux LED 80, 10,5 Watt

### Filter Type

Bioflow S

### Filter Performance

500 l/h, 5,5 Watt

### Adjustable Heater

100 Watt



Black



White

# Rio Line

125

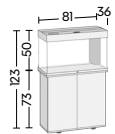

ca. 125 l

180

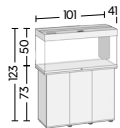

ca. 180 l

240

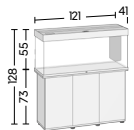

ca. 240 l

290

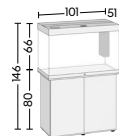

ca. 290 l

350

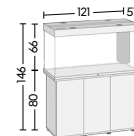

ca. 350 l

450

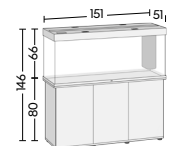

ca. 450 l

## Vision Line

180



260



450

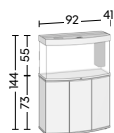

ca. 180 l

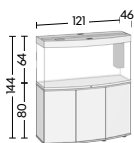

ca. 260 l

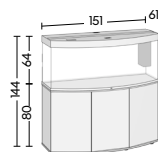

ca. 450 l

## Lido Line

120

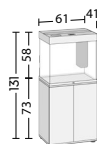

ca. 120 l

200

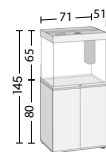

ca. 200 l

## Trigon Line

190

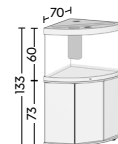

ca. 190 l

350

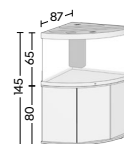

ca. 350 l

# The heart of a JUWEL aquarium

## The Bioflow filtration system



### Eccoflow

#### Circulating pump

Highly-efficient, replaceable and whisper-quiet flow pump of the new Eccoflow generation with double-mounted impeller axle.



### AquaHeat Pro

#### Adjustable heater

Invisible adjustable heater that is integrated in the water circuit.



## 1. Filter phase

---



#### High flow velocity

In the top section of the filter system, the increased flow velocity ensures ideal mechanical and chemical filtering of your aquarium.

## 2. Filter phase

---



#### Low flow velocity

The reduced flow velocity in the bottom section of the filter system benefits the development of bacteria in the anaerobic area, which are essential for the biological filtering of an aquarium.

## Filter System Sizes



Bioflow S



Bioflow M



Bioflow L

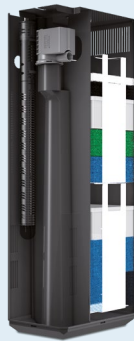

Bioflow XL

## Multiple types of filter media included

Perfectly coordinated filter media guarantee optimum filtering.



**BioPad**  
Filter wadding

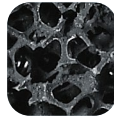

**BioCarb**  
Active charcoal sponge

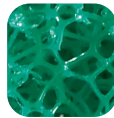

**Nitrox**  
Nitrate remover

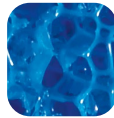

**BioPlus Coarse**  
Coarse-pored filter sponge

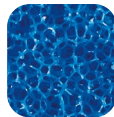

**BioPlus Fine**  
Fine-pored filter sponge

## Optional



**Amorax**  
Ammonium remover



**Carbox**  
Highly effective active charcoal



**Cirax**  
Ceramic granules



**Phorax**  
Phosphate remover



## EccoSkim

Surface skimmer

- Conveys surface residues directly to the JUWEL filter
- Removes residue film and organic residues
- Promotes oxygen content
- Suitable for all aquariums thanks to the provided suction attachment



## FilterGrid

Fine-mesh intake slot

- Reduces the entry of tiny Shrimp and fish into the JUWEL Bioflow Filter
- Reduces the size of the top and lateral intake slots
- Does not reduce the flow rate
- Works with Bioflow Filters Super, M, L and XL

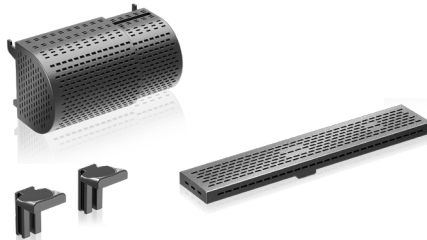

## AquaClean 2.0

- Ideal for cleaning JUWEL filters and ground material
- Including an adapter for cleaning the JUWEL internal filter
- Simple, repeated squeezing of the pump activates the water flow immediately

# MultiLux LED

## The new standard

Aquariums with state-of-the-art LED lighting



Replaceable  
LED tubes



Optimum light spectrum  
for plants and fish



Energy saving

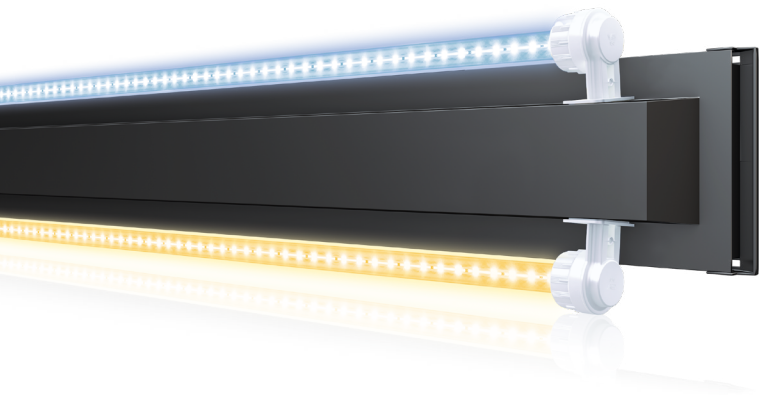

Including  
Lighting media



### LED Day – 9000 K

High-performance LED tubes with bright, stimulating light for your MultiLux LED light unit.



### LED Nature – 6500 K

High-performance LED tube with warm, natural light for your MultiLux LED light unit.





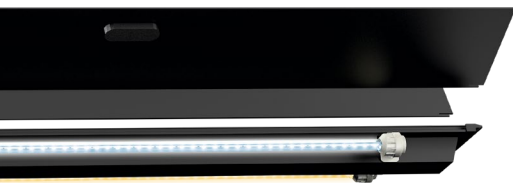

## Optional



### LED Colour – 4425 K

High-performance LED tube with warm, reddish light for your MultiLux LED light unit.

\* Not compatible with T5 light units



## HeliaLux Spectrum

- Specially developed full-spectrum LED light unit with maximum performance
- White, blue, green and red SMD LEDs for maximum brilliance in aquariums



HeliaLux  
AppControl



Compatible with  
Alexa



Hey Google



Works with  
Siri Shortcuts



Download on the  
App Store



GET IT ON  
Google Play

## HeliaLux AppControl NEW

For controlling HeliaLux light units using the MyJUWEL app

- Colours individually controllable
- Individually programmable daily routines
- Individually programmable cloud effects
- With five pre-configured profiles installed
- Control the lighting in your aquarium from anywhere in the world



Made for  
MyJUWEL App

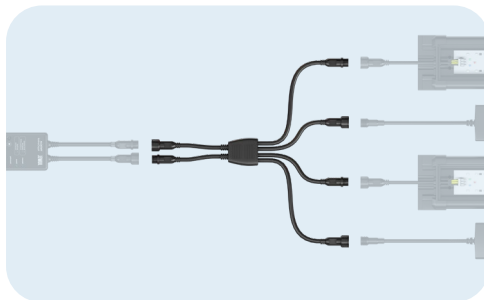
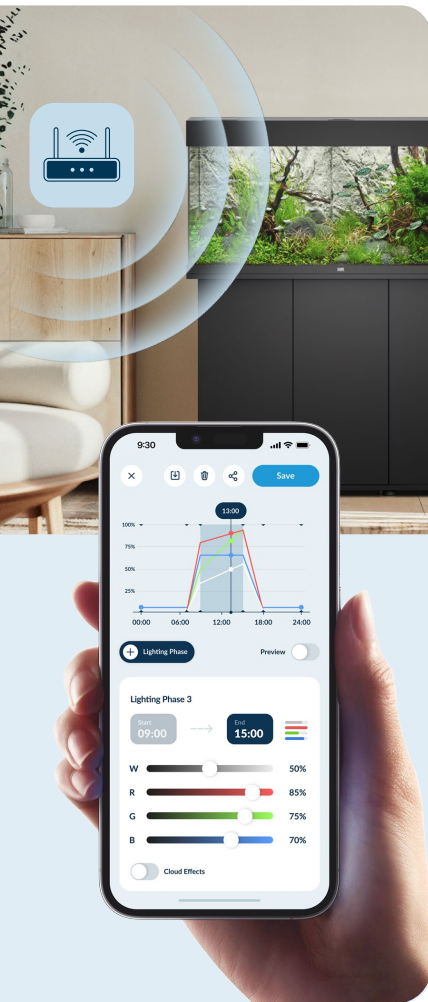

## HeliaLux Splitter

Adapter for operating up to two HeliaLux light units on the HeliaLux AppControl.



**HeliaLux**  
LED Splitter

**HeliaLux**  
Spectrum Splitter

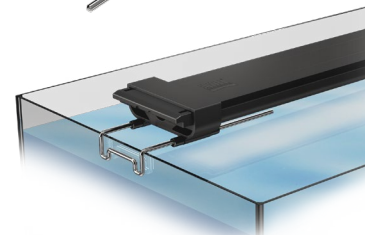
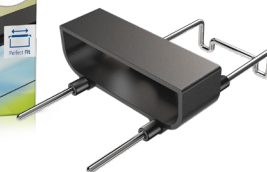

## HeliaLux UniversalFit

Universal bracket for HeliaLux LED compatible with all aquariums.

# SmartCam

Underwater camera

The JUWEL SmartCam allows you to comfortably monitor your aquarium from anywhere.



### PanoramicView

Keep an eye on everything with a 120° camera angle



### EasySnap

Integrated photo and video function



### SimpleShare

Grant camera authorisations so you can share via the JUWEL app



### GlobalAccess

Global access to the camera via the JUWEL app

Perfect  
Fit



## Digital Thermometer 3.0

Perfectly integrated digital thermometer with a large display

- Perfectly integrated into the JUWEL design
- Suitable for fresh and salt water
- Precise: +/- 0.5°C
- Also compatible with aquariums from other manufacturers, thanks to the included suction cup

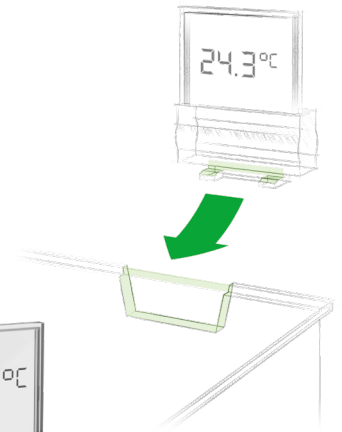

## SmartFeed AppControl NEW

Smart automatic feeder that can be controlled using the MyJUWEL app

- Unlimited number of feedings per day
- Feed quantity dispensable in 8 levels
- A push notification is sent when the fill level of the feed chamber is low
- The app controlled SmartFeed can be controlled from anywhere in the world
- Exchangeable screw conveyors for granulate and flake feeds



Made for  
MyJUWEL App

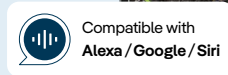
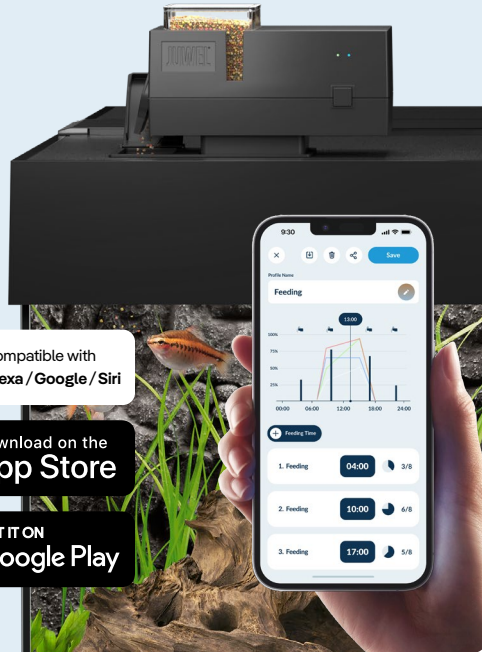

## EasyFeed

The automatic feeder to fit all JUWEL aquariums

- Adjustable feed quantity
- Up to two feedings per day may be programmed

## SmartFeed 2.0

The comfortable automatic feeder for all JUWEL aquariums

- Up to three feeds per day
- Three feeding intervals can be selected (24/48/72h)
- Feed quantity dispensable in 8 levels
- Exchangeable screw conveyors for granulate and flake feeds
- Including feeding chamber extension
- USB port for continuous power supply

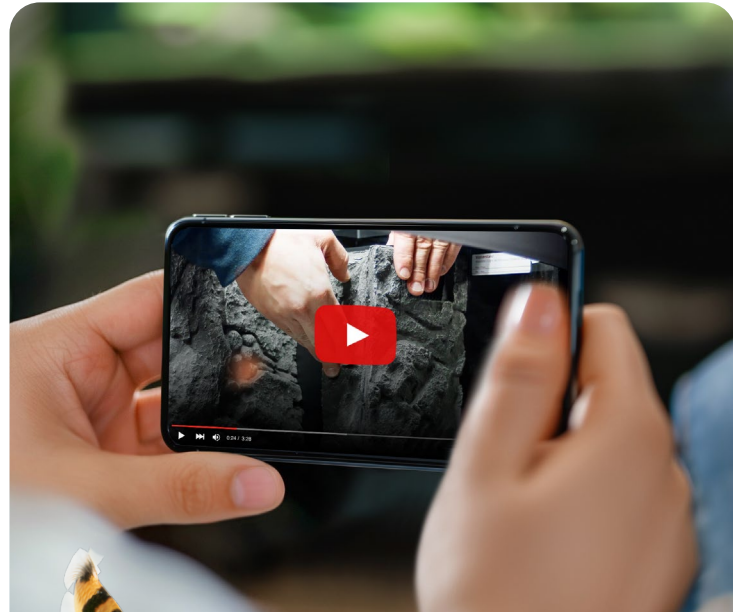

**EasyInstall**  
Set Up Tutorials ▶▶▶

[www.juwel-aquarium.com/set-up-tutorials](http://www.juwel-aquarium.com/set-up-tutorials)



# JUWEL decoration concepts

For a greater effect of depth in the aquarium

## Cliff

- The Cliff Dark decoration concept impresses with its natural brownish hue
- The Cliff Light is a naturalistic reproduction of bright, sand-coloured rock



Cliff Backgrounds



Cliff Filter Cover



## Stone

- The Stone decoration concept is a naturalistic reproduction of a clay- and granite-coloured rock face

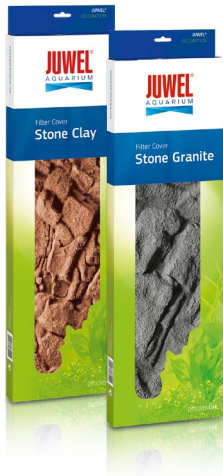

Stone Filter Cover



Stone Backgrounds



STR Background

## STR

- Attractive bark structure

## Conexo

### Decoration adhesive

- For permanent attachment of Backgrounds



# Poster Decor

Poster Backgrounds S, L, XL

- For all aquariums from 60 to 150 cm
- Two attractive motives on each poster



Poster 1 Front

Poster 3 Front

black

Poster 3 reverse

white



Poster 4 Front

Poster 1 reverse

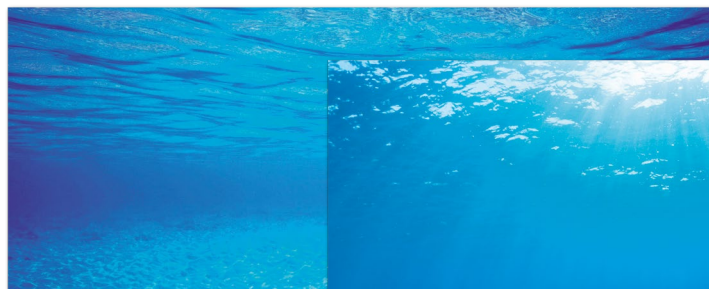

Poster 2 Front

Poster 2 reverse



Poster 4 reverse



### PosterFix

JUWEL PosterFix is an oil that will enhance the three-dimensional effect of your film backgrounds.

- Easy to handle
- Minimises reflection
- Can be removed without a problem
- Improves colour intensity



For further information about JUWEL Aquarium products and JUWEL Aquarium dealers in your area, please visit

**[www.juwel-aquarium.co.uk](http://www.juwel-aquarium.co.uk)**

**JUWEL® Aquarium (UK)**

**A branch of Juwel Aquarium AG & Co. KG**

Gateway 11 Business Park, Penfold Drive,  
Wyndham NR18 0WZ, UNITED KINGDOM

Customer service +44(0)1953 606 363  
Service-Fax +44(0)1953 603 839  
Service-Mail [info@juwel-aquarium.co.uk](mailto:info@juwel-aquarium.co.uk)

® JUWEL, Trigon, Vision, Primo, Rio, Lido, PrimoLux, MultiLux, HeliaLux, NovoLux, HiLite, Twin-Lite, Warm-Lite, Colour-Lite, Day-Lite, Bioflow, FilterGrid, Eccoflow, SeaSkim, JUWEL Aqua Clean, bioPad, bioCarb, Cirax, Nitrax, Phorax, Carbox, Amorax, HiFlex, UniversalFit, NovoLux DayControl, HeliaLux SmartControl, EccoSkim, SmartFeed, EasyFeed

© JUWEL® Aquarium

© Apple and the Apple logo are trademarks of Apple Inc., registered in the U.S. and other countries.  
Design by R —+— J [www.redeleitundjunker.de](http://www.redeleitundjunker.de)

**Presented by:**



Not responsible for typographical errors or misprints.

Subject to change without notice.

INT / 97130 / 2024

INT